

T053 Regular
EN ISO 9100-6 .05

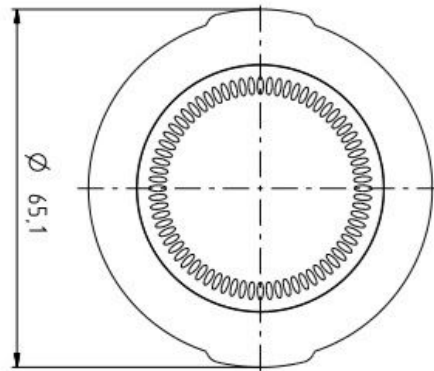
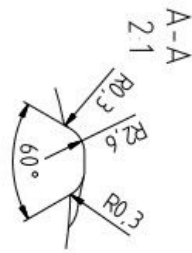
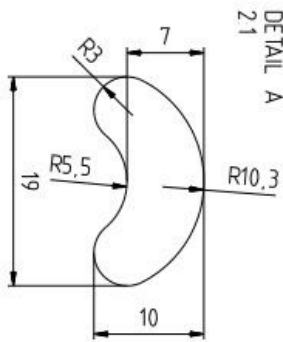
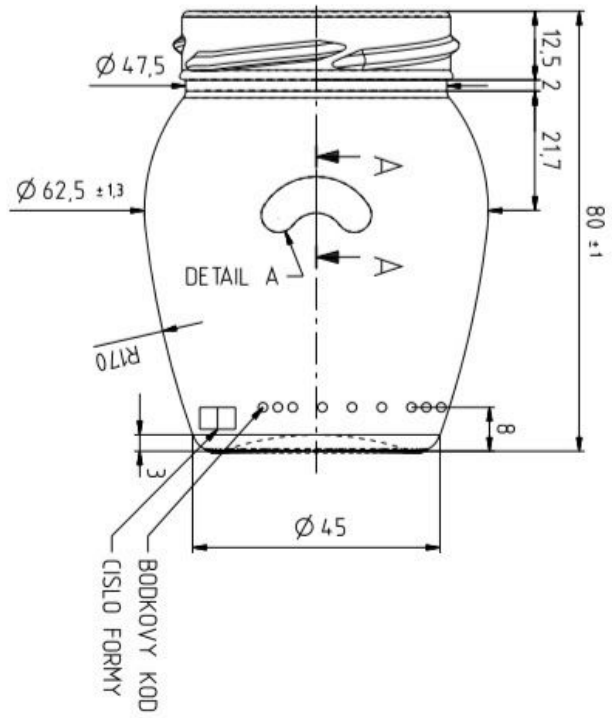
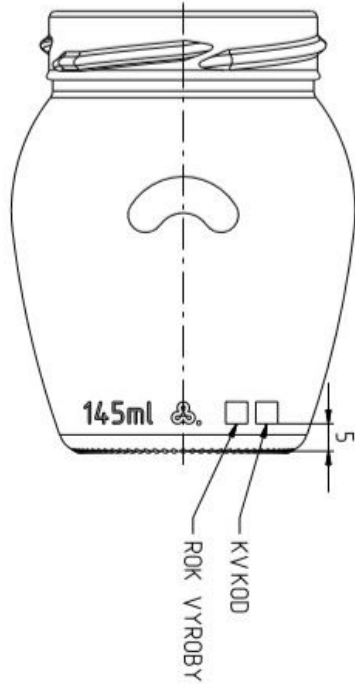

Celkový objem:	145 ml	Výška:	80 mm	145 ml AMFORA
Využitelný objem:	125 ml	Průměr:	62,5 mm	
Typ uzávěru:	TO-53	Velikost etikety:	-	IR THERMIC s.r.o.
Hmotnost:	105 g	Kód produktu:	0047	